

Page 1 STEP 1: INSTALL MOUNTING CHANNELS (Figure 1)

Install HI23 (1" X 2") and HI24 (2" X 2") to floor, starting wall, and overhead of area to be enclosed.

It is suggested that HI23 (1" X 2") channel be used on the floor and walls and the HI24 (2" deep) channel be used on the overhead area to be enclosed to accommodate extreme unlevel or "out of plumb" conditions.

If you are mounting the floor channel to concrete, it is suggested that you use a hammer drill and the (optional) A421A drive anchors to secure the U-channel to the concrete. In addition, use some outdoor/industrial grade waterproofing sealant either between the concrete and U-channel, or on the outside edge of the U-channel against the concrete to prevent water from seeping under the channel and into the room when it rains.

Channel mounted to wall should be sealed against wall by means of 3/4" X 3/4" foam tape (H310A) in the case of step type siding.

Due to the many different types and styles of housing walls, you will need to supply your own screws/fasteners to attach the HI23 U-channel to your house walls.

If possible, allow 12" to 18" overhang on all sides. The top channel will mount under the pans, not under the fascia gutter.

When installing HI24 (2" X 2") channel to your pans, use P401A self-sealing Tek screws for non-insulated panels, and P418's or P432's (long hex head lag screws that will be about 1" longer than the thickness of your insulated panels, with neoprene washers) for insulated panels.

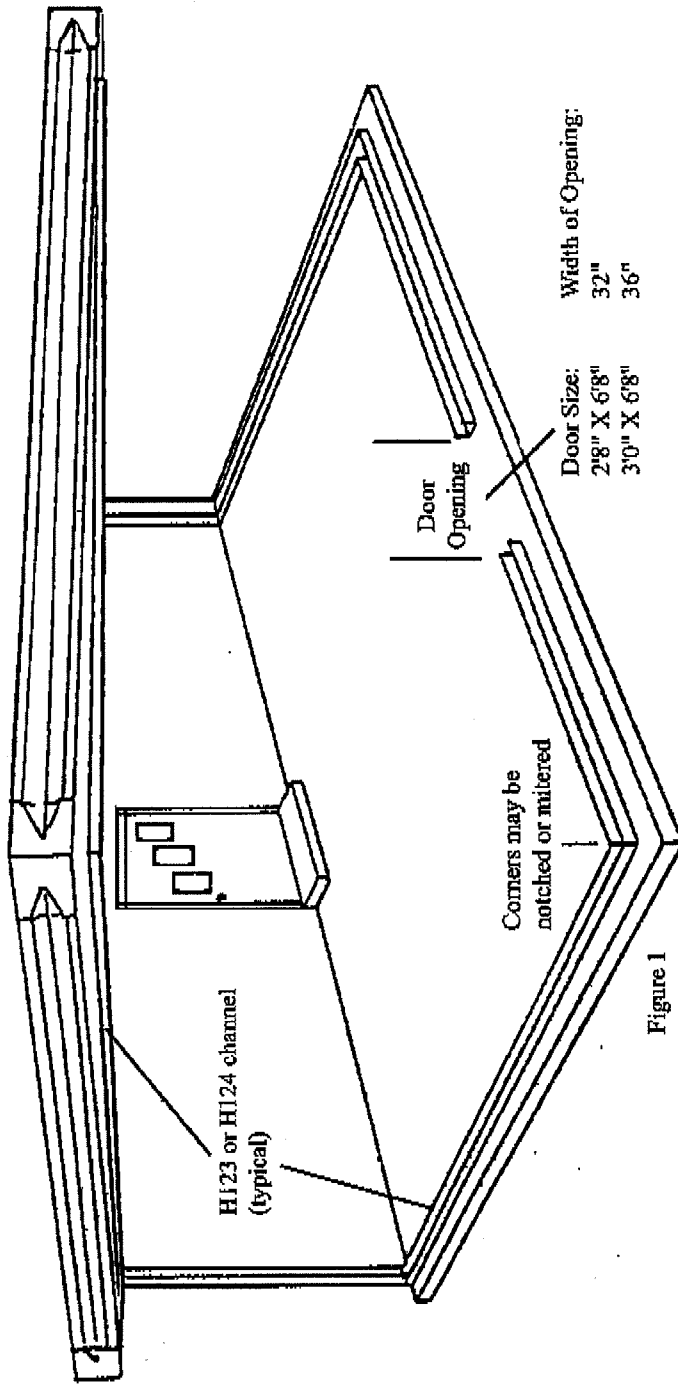

Figure 1

STEP 2: INSTALLATION OF VERTICAL FRAMING MEMBERS (Figure 2)

Install H121 (1" X 2") in channel at wall(s) using wall starter channel as means of plumbing frame. Attach H121 to H123 with H410 Tek screws (Figure 2A).

Be sure not to place H121 all the way down in the U-Channel as you must leave the spline groove exposed for screening.

If you plan on putting your door in the first section against the house wall, use H122 (2" X 2") instead of H121 (1" X 2") in the H123 wall channel.

Install corner posts as shown in Figure 2B (consisting of 2" X 2" member (H120)).

Install 2" X 2" (H122) on either side of door opening, making sure they are plumb and have enough space between to accommodate door to be installed.

Divide remaining wall openings into equal spaces (not to exceed 48") and install and plumb 2" X 2" verticals (H122).

Figure 2A

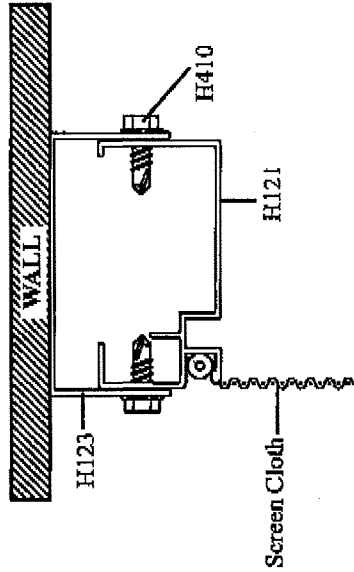

Figure 2B

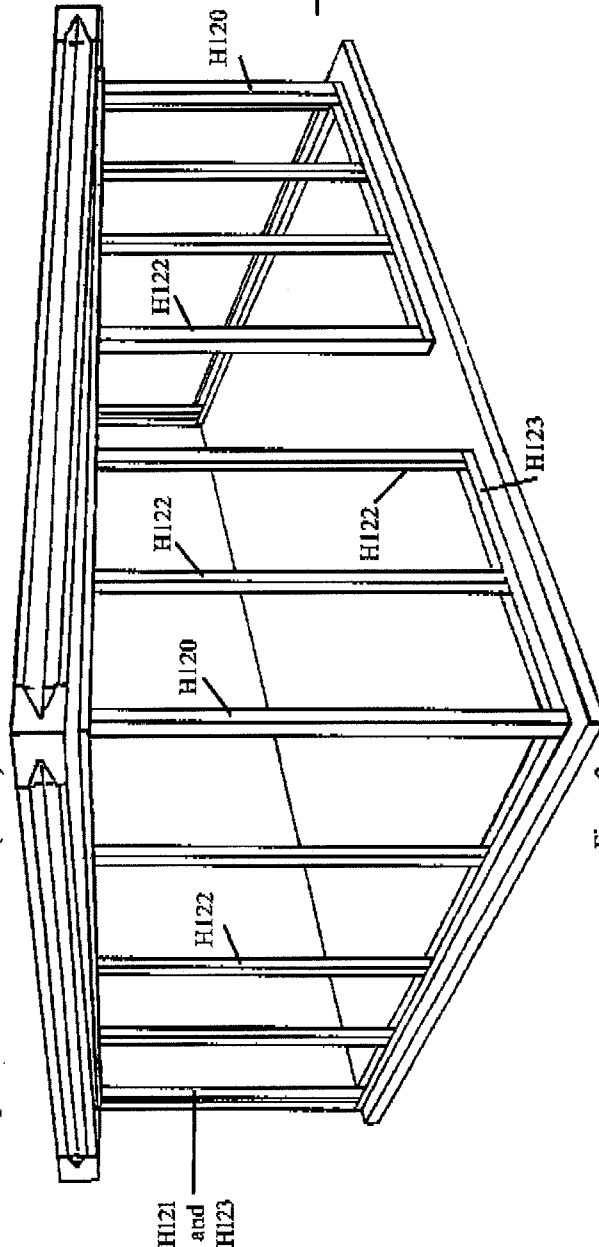
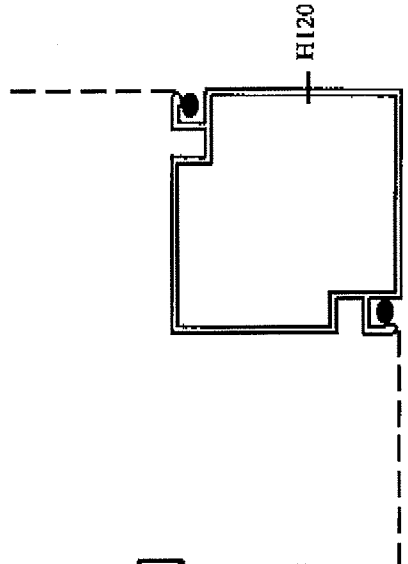
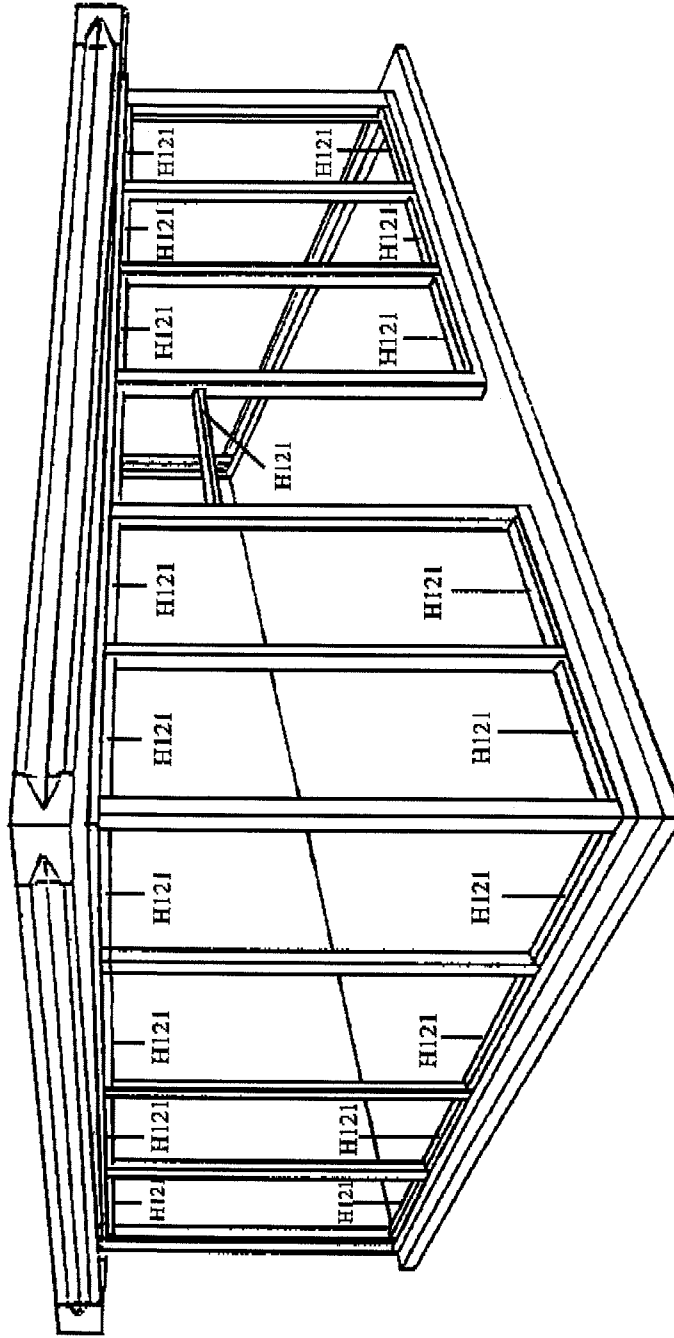
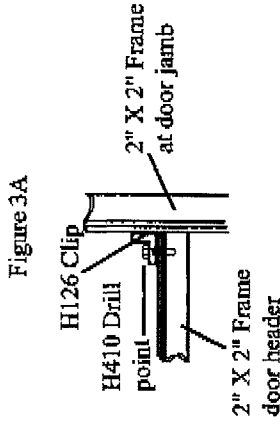

Figure 2

STEP 3: INSTALL HEAD & SILL FRAMING MEMBERS (Figure 3)

Cut 1" X 2" (H121) to fit between vertical framing members at top and bottom and install in top and bottom channels using H410 drill point screws. *Be sure to not drop H121 all the way down in the U-channel as you must leave the spline groove exposed for screening.* Place at the proper level to keep spline groove exposed and then assemble with H410 screws.

Install 1" X 2" (H121) at door head 80" from floor.



STEP 4: INSTALL KICKPLATE

Cut kickplate 3/8" longer than opening width between vertical framing members and insert into slot of bottom rail and vertical member.

To accommodate slope of ceiling or floor, the bottom of kickplate panel may be trimmed to slope.

NOTE: Top of kickplates must be kept even from one opening to the next. This may be accomplished by aligning top of kickplate with string stretched at desired height.

Secure kickplate in frame by rolling rubber spline into kickplate groove along interior surface of kickplate, bottom and both sides.

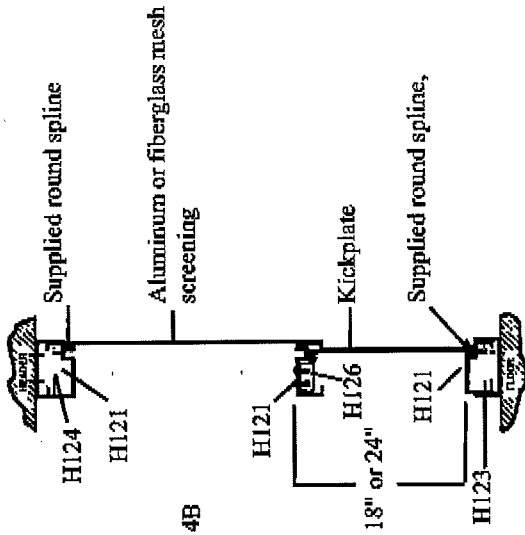

Figure 4B

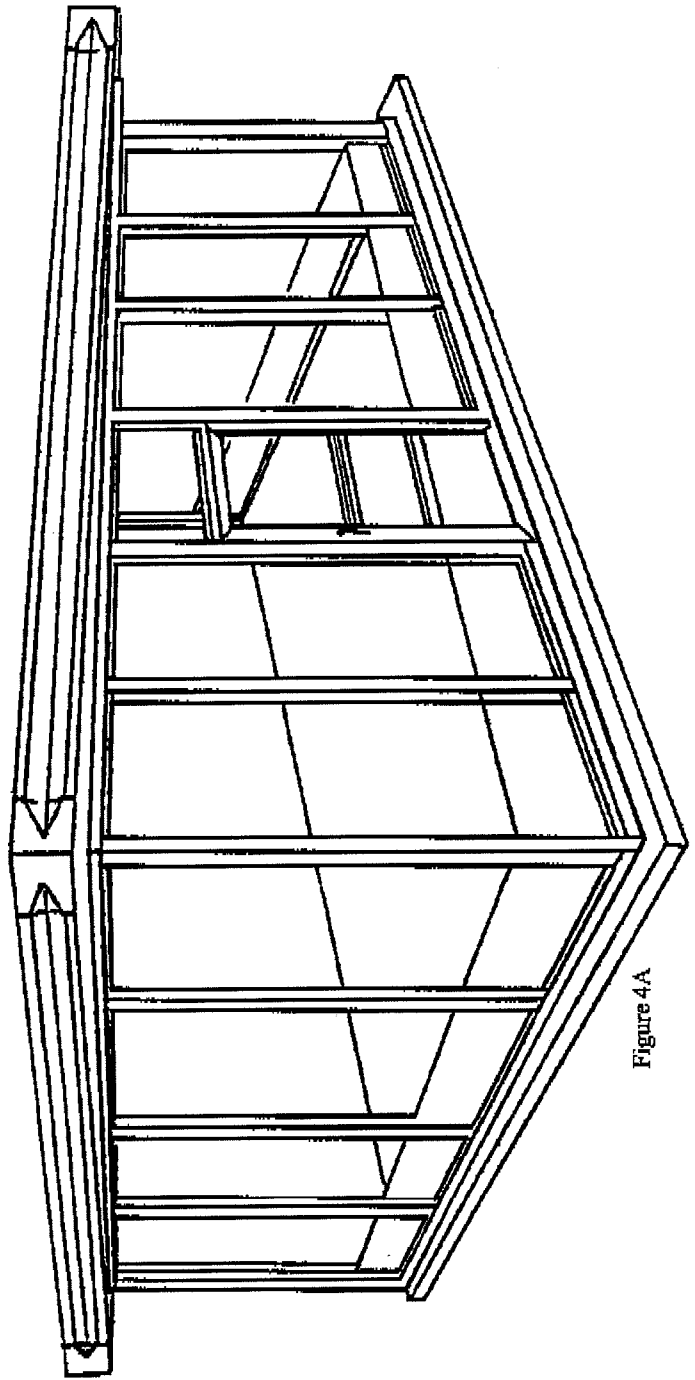

Figure 4A

STEP 5: INSTALL KICKPLATE RAIL (Figure 5)

Cut 1" X 2" (H121) to fit between vertical framing members right above the kickplate. Temporarily set H121 over kickplate and make sure the kickplate slides completely into the designed groove in the H121. Once it is firmly seated, take an H126 clip and slide it up under the H121 to where it meets each vertical framing member. With a pen, lightly mark the 2" X 2" vertical framing member where the clip ends with a line. Then remove the 1" X 2" (H121) and screw the H126 clips (one per side) to the vertical 2" X 2" framing members using your mark as a guide for the bottom of the clip. As another reference, the top of the clip should be about 1/4" above the top of the kickplate.

Then, place the 1" X 2" mullion (H121) back on and screw down (from the top of the H121 down) to the clips with the supplied H410 Tek screws.

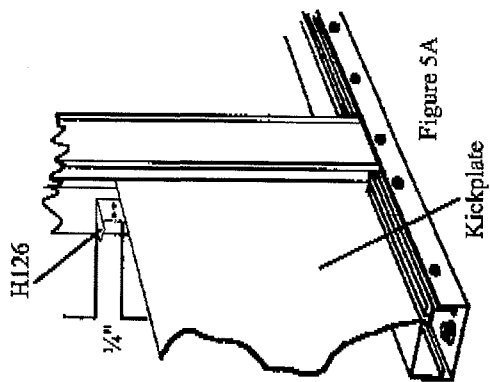

Figure 5A

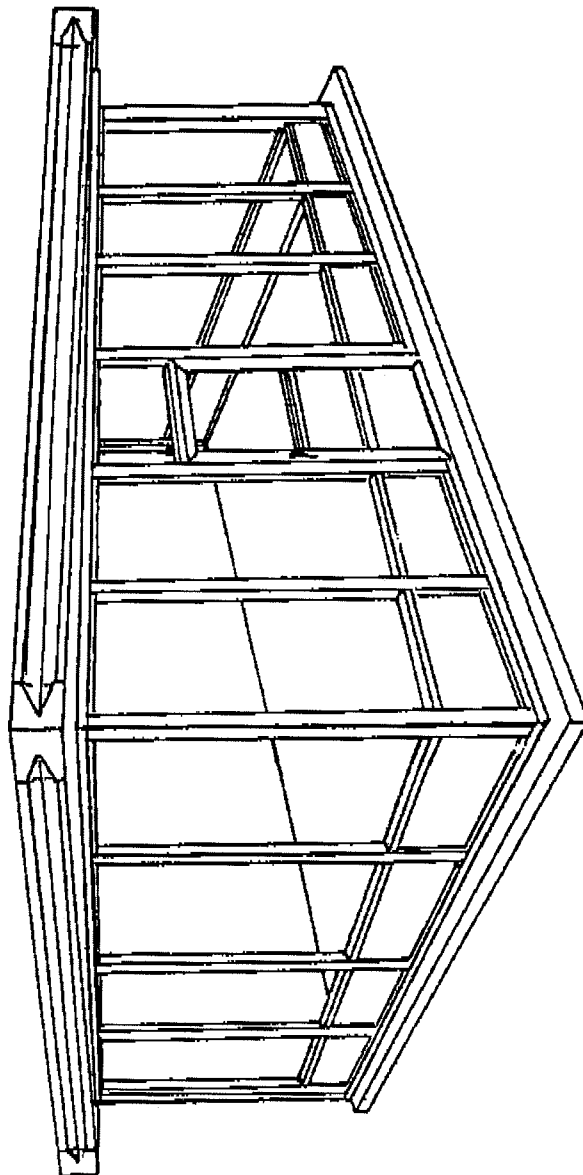

Figure 5

Step 6: INSTALL SCREENING (Figure 6)

Use supplied Vinyl Spline.

Roll fiberglass screening and spline into the jamb sections first, then roll screening and spline into top and bottom.

Step 7: INSTALL SCREEN DOOR IN OPENING (Figure 6)

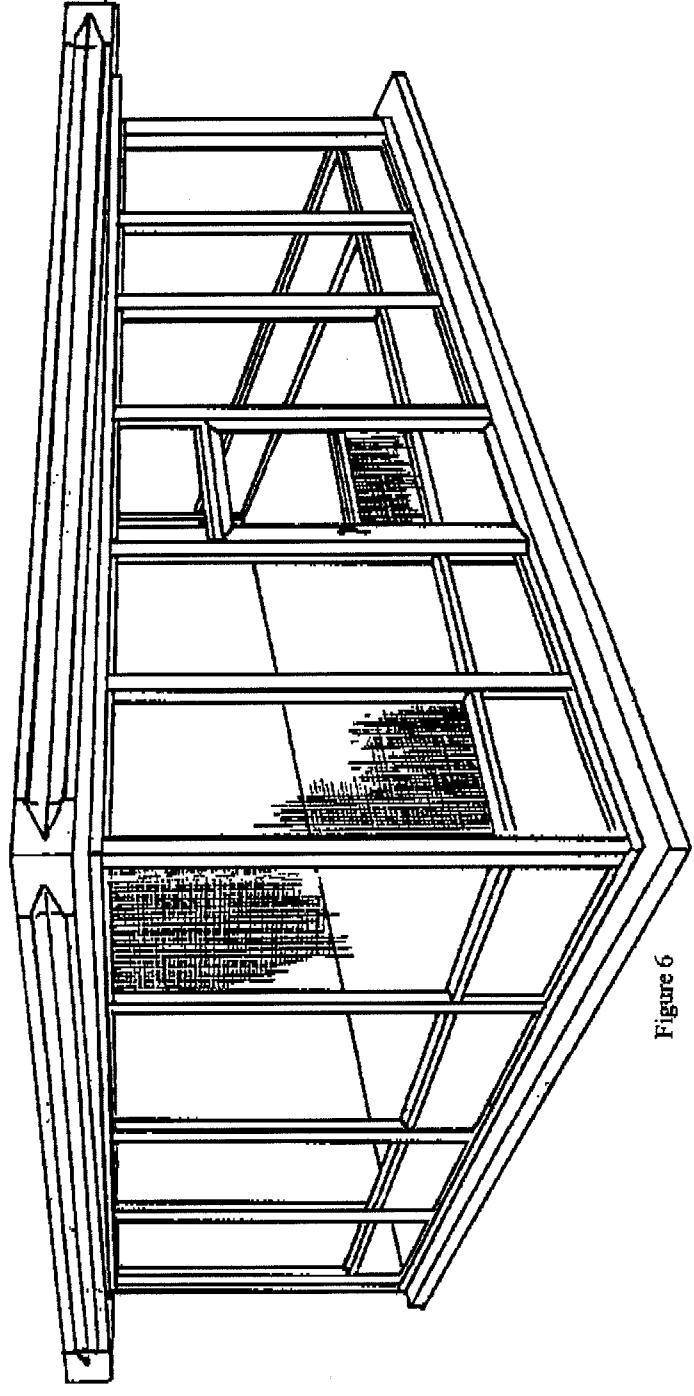

Figure 6

